

THE POTENTIAL OF NON-CONTACT CLOSE RANGE LASER SCANNERS FOR CULTURAL HERITAGE RECORDING

Boehler, W. ⁽¹⁾, Heinz, G. ⁽²⁾, Marbs, A. ⁽¹⁾

⁽¹⁾ i3mainz, Institute for Spatial Information and Surveying Technology, FH Mainz, University of Applied Sciences, Holzstrasse 36, 55116 Mainz, Germany, i3mainz@geoinform.fh-mainz.de

⁽²⁾ Roemisch-Germanisches Zentralmuseum, Ernst-Ludwig-Platz 2, 55116 Mainz, Germany

CIPA Working Group VI

KEY WORDS: Laser scanners, close range, cultural heritage recording

ABSTRACT:

The use of laser scanning methods for the close range measurement of fixed objects has recently become popular in the design and manufacture of automobiles, and in body scanning. Laser scanning instruments, mainly developed for such industrial applications, are also suitable for cultural heritage recording. The two basic types currently available are ranging lasers and triangulation-based devices. With the latter, a light projection is imaged by a CCD camera at a fixed distance. A triangulation type of scanner (MENSI SOISIC™ LD with 3Dipsos software) is described, the results of scanning trials are reported and various complexities are pointed out. Objects recorded include a statue, a sculptural arrangement, an unearthed Roman boat and architectural facades. We conclude that laser scanning is a valuable new method for cultural heritage recording and one which will complement, and, in certain applications, replace currently existing methods.

1 3D SCANNING

1.1 Principles of Operation

3D scanners record three-dimensional coordinates of numerous points on an object surface in a relatively short period of time. To accomplish this, a laser beam is projected onto the object surface. The scanning effect is achieved using one to two mirrors which allow changes of the deflection angle in small increments. In addition, the entire instrument and/or the object may be rotated to achieve a complete 3-dimensional point coverage. High-accuracy recording of angular settlements is important, since the angles together with the distance measurements determine the reflecting point position.

Two different principles for distance measurement are in use: Ranging lasers using the "time-of-flight" principle and instruments using CCD cameras where distance measurement is based on the principle of "triangulation".

Time-of-Flight: The so-called "time-of-flight" or "ranging" scanners have a laser diode that sends a pulsed laser beam to the scanned object. The pulse is diffusely reflected by the surface and part of the light returns to the receiver. The time that light needs to travel from the laser diode to the object surface and back is measured and the distance to the object calculated using an assumed speed of light. (Fig. 1).

Ranging scanners are able to measure much longer distances than instruments that work by triangulation. They are, however, less accurate and especially so at close range. The accuracy is between some millimeters and two or three centimeters, depending to some extent on the distance between the object and the scanner (object distance).

Triangulation: The second group of scanners is based on a simple triangulation principle. A light spot or stripe is projected onto an object surface and the position of the spot on the object is recorded by one or more CCD cameras. The angle of the light beam leaving the scanner is internally recorded and the fixed base length between laser source and camera is known from calibration. The distance from the object to the instrument is geometrically determined from the recorded angle and base length (Fig. 2). This type of

scanner reaches 3D point standard deviations of less than one millimeter at very close range (less than 2 meters). The accuracy depends on both the length of the scanner base and the object distance. With a fixed base length, the standard deviation of the distance measurement will increase in proportion to the square of the distance.

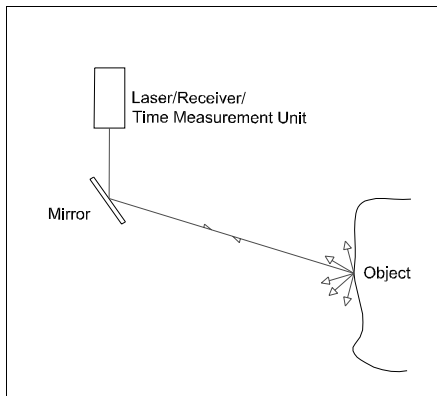

Figure 1: Time-of-flight

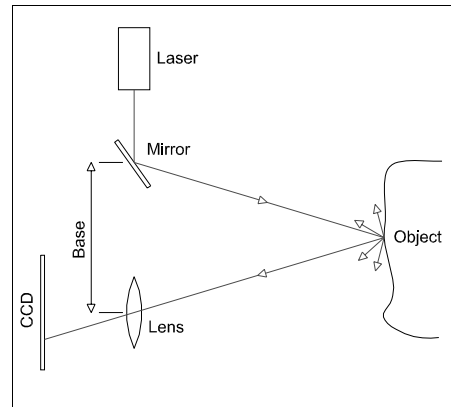

Figure 2: Triangulation

Image matching. If two cameras are used at the end of a base, image-matching techniques can be used to compute 3D coordinates of large numbers of object surface points. If the object is close and lacks detail, a pattern projector can give the necessary texture. These techniques, well established in photogrammetry, are not included in this paper, although they should always be considered for recording tasks similar to those described below.

1.2 Processing of Results

Scanning results in a cloud of isolated 3D points. Although the measuring process is very fast and simple, users should be well aware that, in addition to an appropriate software, time and patience are needed to arrive at a final result in the form of a CAD drawing or a surface representation with a triangulated mesh. Processing procedures should include recognition and elimination of wrong or inaccurate points. Since most objects have to be recorded from several viewpoints, methods to combine the separate point clouds have to be incorporated.

If a CAD representation is desired, the software must be able to fit primitives (i.e. planes, cylinders and spheres) to selected parts of the point cloud. In the case of an irregular surface, tools are needed to create a triangular mesh. In either case, it may be necessary to map textures onto the created surfaces in order to achieve a photo-realistic appearance. The necessary digital images may derive from CCD cameras that are part of the scanning device or from external imaging systems.

1.3 Overview of available scanners

In the past few years many 3D scanners aimed at a variety of users and applications appeared on the market. The majority was produced for scanning, surveying and modelling of small objects of sizes ranging from coins to cars. The set-up for scanning of human bodies or body parts quite naturally allows also for the scanning of (about life-sized) sculptures or statues. As a result, these instruments are useful for some cultural heritage purposes although the producers constructed them just for applications in medicine or the clothing industry. The underlying principle of triangulation guarantees both high accuracy at distances below two meters and suitably fine grid resolution for small and detailed objects.

The number of scanners that are available for larger objects or scenes is much smaller. Due to the poor accuracy of triangulation scanners at large distances, most of them work by “time-of-flight”. Naturally it is not sensible to scan distant objects with a grid resolution much smaller than the diameter of the laser spot on the object surface. Although some manufacturers equip their scanners with a laser auto-focus, the spot size grows with increasing distance. This explains why detailed scanning from large distances is not sensible.

	Producer	Type	Range	Princ.
Mid Range	Riegl Laser Measurement Systems	LMS-Z210	450	tof
	Callidus Precision Systems	Callidus	80	tof
	MetricVision	MV 200	60	tof
	Zoller+Froehlich GmbH	LARA	55	tof
	Cyra Technologies	Cyrax 2500	50	tof
	Mensi	SOISIC	25	tof
	3rdTech	DeltaSphere	12	tof
Close Range	Breuckmann	optoTOP	5	tri
	Digibotics	Digibot	1.8	tri
	GOM mbH	ATOS	1.6	tri
	ABW GmbH	Kombi-640	1.5	tri
	MEL Mikroelektronik GmbH	M2D	1.2	tri
	Minolta	VI	1.2	tri
	3D Digital Corporation	Model 100, 200, 300	1	tri
	Cyber F/X	various	ca. 1	tri
	Cyberware	various	ca. 1	tri
	Intelligent Automation	4DI	ca. 1	tri
	Laser Design	DS, RE, PS	1	tri
	Vitronic	Vitus	ca. 1	tri
	Polhemus	FastScan	0.8	tri
	Steinbichler Optotechnik	various	0.8	tri
	Shape Grabber	various	0.7	tri
	SCAN technology	various	0.6	tri
	DLR German Aerospace Center	Laser Range Scanner	0.3	tri
	INO	3D Laser Profiling Sensor	0.3	tri
	INTECU	Cylan	0.3	tri
	Nextec	Hawk	0.3	tri
	Roland	Picza	0.3	tri
	3D Scanners, Nvision	ModelMaker	0.2	tri
Kréon	KLS	0.2	tri	
3DMetrics	3DFlash!	0.1	tri	
Hymarc	Hyscan 45c	0.1	tri	
Perceptron	Contour Probe Sensor	0.1	tri	



Figure 3: SOISIC scanner

Table 1: Overview of available scanners sorted by range (tof = time-of-flight principle, tri = triangulation principle).
From WWW 2001.

2 SOISIC SCANNER BY MENSİ

2.1 Specifications

The SOISIC scanner, recently purchased by i3mainz, is based on the plane triangulation principle combined with a cylindrical rotation. The French producer, Mensi, offers two different versions: SD has a base (distance from laser mirror to camera lens) of 0.5 m for distances between 0.8 and 10 m, and LD has a base of 0.8 m for distances between 2.5 and 25 m.

The scanner bought by i3mainz is the long distance version. It was chosen because it is amenable to scanning both, smaller objects like statues, and larger objects such as archaeological sites, caves, rock walls, facades, and so on. The SOISIC scanner fills the gap between close and mid range scanners (cf. table 1). Due to its relatively large base (as compared to other triangulation systems), it is possible to scan objects at 10 meters and more with good accuracy.

The basic components of the system are the SOISIC scanner itself, a tripod (1 to 1.8 m), a remote control PC with 30 m of cables, a calibration bar and ten spheres for registration. It is possible to mount the scanner on the provided tripod both horizontally and vertically. If there is little space at the scanning site, it can be put on the ground (horizontally).

The SOISIC scanner is a cylindrical instrument with two openings, one for the laser diode and the other for the CCD camera. An additional video camera is installed next to the CCD. It is used to control the scanner by the PC. Furthermore, it is possible to use the video imagery for texture mapping on the processed 3D model. An integrated stepping motor enables the scanner to rotate and capture a 320° field of view in the vertical direction. The scanning field in the base (horizontal) direction is derived from the camera's field of view and is about 46°.

The scanner is able to record approximately 100 points per second. To use the resulting cloud of points for creating models, Mensi provides the 3Dipsos software. Here the points are managed, edited and filtered. Special modules allow the creation of triangulated meshes and regular objects for engineering purposes as well as the management of imagery and mapping of photo textures onto the model. The

finished objects or models can be exported in formats such as OBJ, STL, DXF, DGN and VRML. Additionally, 3Dipsos allows the importing of ASCII coordinate files from any scanner or other sources to work with these points.

As mentioned above, ten red spheres are included with the scanner. These spheres can be used as connecting points in order to combine several viewpoints together into one coordinate system. An algorithm is integrated in 3Dipsos, that automatically detects these spheres in the cloud of points and calculates a transformation connecting two viewpoints with $n > 3$ identical spheres. A sphere with an integrated retro-reflector is available, allowing a simultaneous position determination with geodetic total stations. If object features are used, interactive and/or automatic registration without spheres is also possible.

2.3 Tests and Problems

Accuracy. The accuracy of the system is determined by the accuracy of the angle β (see Fig. 4), which is derived from the image of the laser spot on the CCD. The angle α (mirror rotation) can be read with much higher accuracy from a coded circle and the base can be determined from a calibration. If β is not determined correctly, the incorrect point position will be computed somewhere on the ray originating from the laser mirror (Fig. 4). If β is the only error source, it can be predicted that point accuracy is constituted only by the accuracy of the distance from the laser mirror and that this accuracy decreases with the square of this distance.

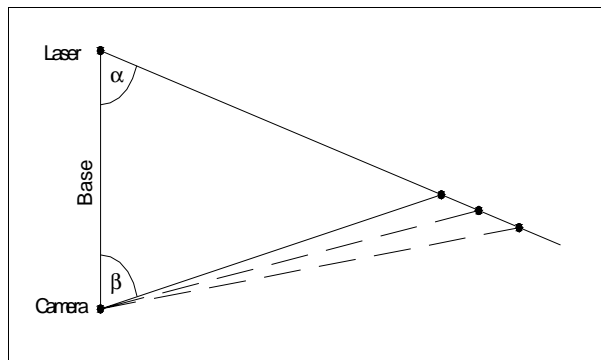

Figure 4: Influence of wrong angle on point position

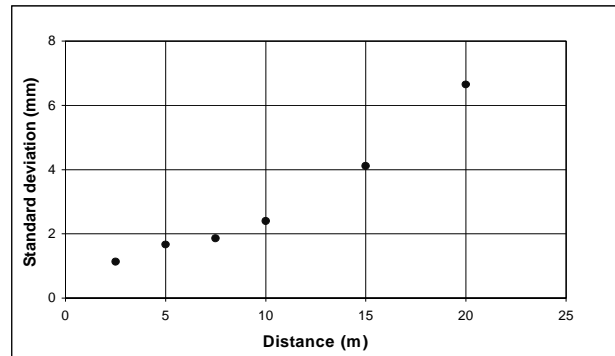

Figure 5: Standard deviations of distance measurements

Our tests included scans of plane objects at varying distances. After fitting a plane to the cloud of points, 3Dipsos displays the standard deviation. The results shown in figure 5 clearly indicate the expected increase by the square of the distance. For distances below 20 m the standard deviations can be well approximated by the function

$$\sigma = \pm (0.80 + 0.015 s^2) \text{ mm}$$

where s is the distance expressed in m.

These results, which were nearly identical for different object materials, unfortunately did not meet the specifications of the producer (MENSI 2000, 2001) who claims a standard deviation of 0.3 mm at 2 m and 0.6 mm at 5 m, suggesting a function of

$$\sigma = \pm (0.25 + 0.015 s^2) \text{ mm.}$$

Since the standard deviation is a statistical value only, it is important to note that many single point measurements exceed this value. The resulting image of the point cloud of a plane, which would appear as a thin line when the standard deviation was near zero, appears with a visible thickness amounting to twice to three times the standard deviation. By scanning surfaces at an angle of approximately 45° , better-looking results are achieved: the thickness of the cloud of points is smaller because the direction of the main error component is no longer perpendicular to the surface. When scanning artificial objects like sculptures etc., a strong smoothing of the point clouds is necessary to reduce their thickness and to create a flatter surface for triangulation. Of course, this also results in a loss of detail and therefore should be used with extreme caution.

Edges. Another problem is the behaviour of the scanner at edges or projecting parts. When the laser beam moves over such an edge, not the whole spot is reflected but just a small part of it. The camera records that part of the spot and interprets it as a whole spot (Fig. 6). As a result, many erroneous points are produced which are shifted in laser direction (cf. Figs. 4 and 7). After scanning, these points have to be removed manually from the cloud of points through a time-consuming process. As every 3D point in 3Dipsos looks the same, it is difficult to identify the incorrectly placed ones and to be sure that no correct points are deleted.

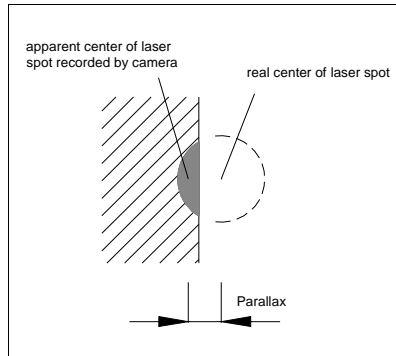

Figure 6: Parallax that leads to incorrect points at edges

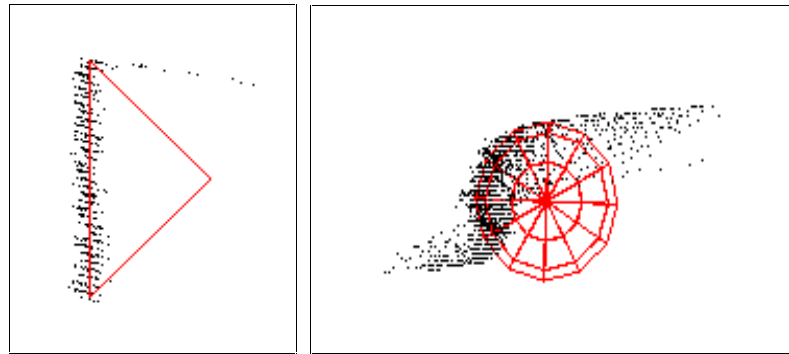

Figure 7: Object surface point uncertainty and incorrect points (the scanner is located to the left of the above images).
Left: At sharp edge. Right: At sphere in large distance from the scanner.

Influence of material and illumination. As laser scanning is an optical method, it is of interest to investigate the influence that illumination and material type have on the reflection of the laser spot and the resulting quality of the measured points. The SOISIC scanner works with a class III-B laser in the red visible spectrum ($\lambda = 640 \text{ nm}$) which is eye-safe as long as just one single laser pulse hits the eye. But the laser power is too low for scanning outside at bright daylight. At surrounding illuminations of ca. 5.000 to 10.000 lux and above the camera is not able to identify the laser spot. This, of course, also depends on the object distance.

In addition to the surrounding light intensity, the colour and surface of scanned objects are important. The best reflection of the laser light is achieved from smooth red surfaces, like the red spheres delivered with the scanner. When the object is rough and dark, much of the laser light is absorbed and missing points can be observed. Tests show, that the point accuracy depends slightly on the reflectivity of the scanned object, especially at short distances.

Registration spheres. For most of the projects it is necessary to scan from several viewpoints. Our experience so far shows that the spheres are useful as connecting points at distances up to 10 meters. Placing them further away leads to problems due to decreasing point accuracy and the effect shown in figures 6 and 7. The point cloud becomes deformed and automatic sphere registration in 3Dipsos is not appropriate. An alternative would be the use of larger objects or the use of distinct details of the scanned object itself to combine points from different viewpoints.

2.4 Applications

So far we have been able to scan a number of different objects and sites. This included the scanning of a small Yemeni statue, sculpture arrangements of mausoleums at Mainz Cathedral, unearthed remains of an ancient Roman boat, as well as facades of an old church ruin in the Palatinate region.

Statue. The statue is an 80 cm high copy of an ancient Yemeni statue. It is made out of smooth synthetic material, similar to bronze.

The aim was to create a detailed 3D model within a justifiable amount of cost and time expenditure. The scanning procedure took one working day, using 11 different viewpoints and recording 780,000 points. Four spheres were placed on the pedestal of the statue to maintain view registration when it was moved to allow the different views. The whole process of evaluation in 3Dipsos to create a detailed 3D model (as shown in Fig. 8) including application of textures took about 10 days. Geometrical mesh construction took

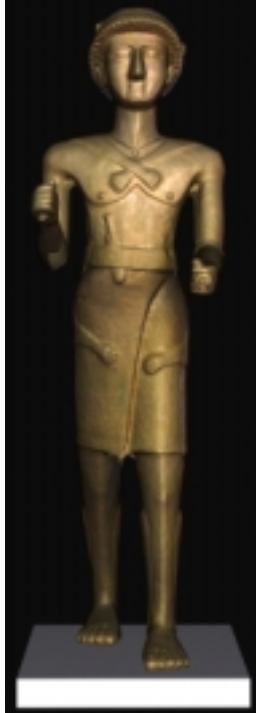

Figure 8: 3D model of Yemeni statue, rendered with original textures

five days and texture application took another five days. An experienced user may need only half as much time.

Since no registration sphere could be placed above the head of the statue, an interactive and automatic registration using the point clouds of the statue was successfully used. To get an even model surface it was necessary to delete error points manually and apply a point cloud smoothing. Without applying such a procedure the model would look very granular. Next a „spatial sampling“ was applied to create a point cloud with a regular grid of 0.5 millimeters. Finally 355,000 points were used for the mesh; the finished model consisted of 710,000 triangles. The triangulation process was comparatively time-consuming: The point cloud had to be divided into many parts, each of which contained unique parameters and were used for individual meshing. The alternative to individual meshing, applying an automatic triangulation on the whole point cloud, produced an unsatisfactory result: many holes appeared in the 3D model due to areas of lower grid resolutions. These individual meshes had to be stitched together, which is predominantly a manual and time-consuming process.

Mapping texture images onto the finished model demands the input of identical points in both the model and the image. If this procedure is not done very accurately by an experienced user, the algorithm tends to fail. Furthermore, it should be noted that a powerful PC (high performance graphics card and at least 512 MB RAM) is needed to achieve acceptable speed when moving the object on the monitor and when triangulations and texture mapping tasks have to be calculated by 3Dipsos.

Sculptures. Several sandstone mausoleums at different locations at Mainz Cathedral had to be scanned because sizes and dimensions of both the entire arrangements and single figures within the arrangements were needed. The largest scanned monument was 4 meters in height and 10 meters wide. This could easily be achieved with one viewpoint and less than two hours of scanning



Figure 9: 3D model of sculpture, without textures. Size about 3.5 m x 4 m.



Figure 10: Detail of a ruin wall (without texture) containing quarry stones and cut stones. Size about 2.3 m x 1.8 m.

time for each mausoleum. The determination of discrete sizes using the mesh or the point cloud was quite simple in 3Dipsos. By clicking on two points both 2D (referring to the plane of projection) and 3D distances are displayed. Two more viewpoints were used to create a denser point grid and to reduce the shadowed areas. This could be used to produce a quick mesh. The result for a part of a monument is shown in Figure 9.

Church Ruin. Figure 10 shows part of a church ruin wall containing different types of irregular stones. The image shows a 3D model scanned with a 4 mm grid width and rotated to show the front elevation. No texture was applied; the gray tones are just the result of a virtual illumination. It can be seen that laser scanning is well suited to document such a complicated scene. In addition to an orthophoto type plan, all information about the third dimension (joint depth, wall tilt, ...) can be derived. If a CAD representation is needed, the necessary digitization has to be done manually using the scanned image, which adds considerably to the overall expenditure. It should also be noted that scanning at this high resolution takes a long time (about 10 minutes per square meter) and has to be accomplished during night time for the outsides of buildings.

Since the instrument should not be located too far from the wall, it was not possible to document the higher parts of the building in this way. Here, images were taken with a digital camera from a hydraulic lift. The laser scanner could be employed anyhow, since a scan with a wide grid (5 cm) was used as digital object model for the creation of the orthophotos.

Roman boat. The restored remains of the Roman boat shown in figure 11 were scanned during nine nights in a museum from 30 viewpoints, including complementary scans of small areas. The object has a length of 15 meters and a width of 3 meters. Since no spheres were used, the single views had to be combined without tie-points. After a coarse matching by an operator, the final matching could be achieved by automatic registration using the overlapping parts of the point clouds.

Scanning at night was necessary because it was not allowed to work during the opening hours of the museum. So the whole scanning process took a lot of time but there was no disturbance by visitors or employees of the museum.

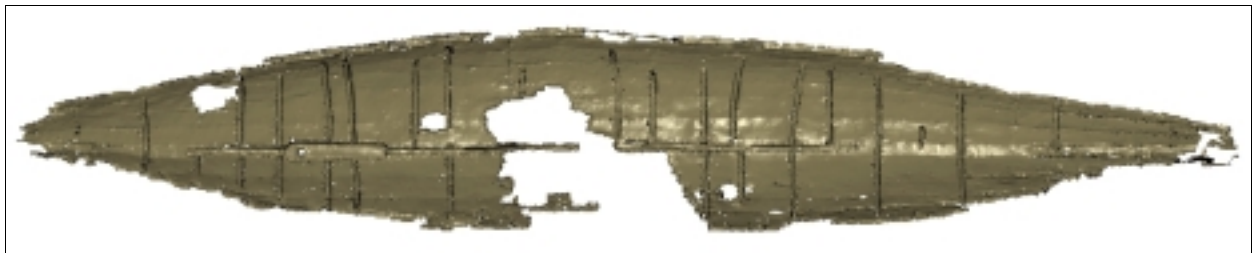

Fig. 11: Remains of a Roman boat

The matching process of 30 viewpoints resulted in a cloud of nine million points. After deleting the points which did not belong to the boat and reducing the rest of them to a 3 mm grid, the final point cloud amounted to 1.6 million points as a basis for the creation of meshes. The model shown in figure 11 is the result of an automatic triangulation with a medium triangle side length of 12 millimeters. To get a more detailed model of the boat the triangle side length has to be decreased and a lot of time is needed for eliminating errors and filling holes of the raw mesh.

Despite the high expenditure of scanning and postprocessing time there is no alternative method for such a detailed three-dimensional registration of complex objects.

3 CONCLUSIONS

The main advantage of scanning is the fast and direct collection of large numbers of surface object points. The measurement process needs no attendance except for the set-up required when establishing a new viewpoint. As compared to tacheometric surveying, this equates to a much higher productivity.

The main difference between scanning and photogrammetry is obvious: While photogrammetric surveying is an indirect data acquisition method (images are needed before measurements can be executed), scanning produces 3D points directly.

As geodetic surveying instruments, scanners cannot be used when the object or the observation platform is moving. In these cases, photogrammetric images, which can be acquired with very short exposure times, are the only means of metric documentation.

Laser point size, grid resolution and accuracy issues limit the resolution achievable in scanning an object. In this respect, the results are very similar to image matching in photogrammetry.

Laser scanning accuracy cannot reach the accuracy of geodetic instruments and does not provide the possibility to increase accuracy through larger image scales as can be done in photogrammetry.

Since it is not possible to record discrete points, which is the principle in tacheometry and can also be achieved with photogrammetric images, scanning needs post-processing procedures which can be time-consuming.

Consequently, laser scanning can replace or complement methods used so far (Böhler 1999) in metric cultural heritage documentation when complicated objects have to be recorded economically with moderate accuracy requirements.

ACKNOWLEDGEMENTS

The laser scanner was acquired using specifically allocated funds provided by the Minister of the Department of Education and Science (MBWW) Rhineland-Palatinate, who established a 'Center of Competence for Spatial Information Technology in the Humanities' at the i3mainz.

Thanks to Lisa Brown who assisted in the research and in the formulation of this paper.

BIBLIOGRAPHY

Böhler, W., Heinz, G., 1999: Documentation, Surveying, Photogrammetry. XVII CIPA Symposium, Recife, Brazil, Proceedings. (Also available at www.i3mainz.fh-mainz.de.)

MENSI 2000: SOISIC 2000 Scanner User's Manual, Release 1.0.

MENSI 2001: Mensi training materials, German training course, May 2001.

WWW 2001: An extensive collection of links to laser scanner producers and reports about applications in cultural heritage is maintained by the authors at <http://scanning.fh-mainz.de>